



INOX - IVR 655



 Valvola di ritegno in acciaio inox AISI 316 - attacchi F/F

 Stainless steel AISI 316 vertical check valve - threaded ends F/F

 Rückschlagventil aus Edelstahl AISI 316 - IG/IG

 Vanne de retenue en acier inox AISI 316 - fixations F/F

 Вертикальный обратный клапан из нержавеющей стали AISI 316 - Соединения В/В

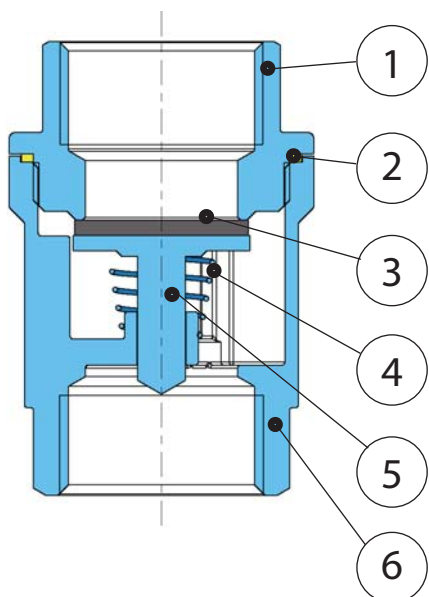

Size 
1/4"-4" 64 bar

Estremità filettate
UNI ISO 228/1

 Max
+180° C
Min
-25° C

N	DENOMINAZIONE PART NAME	MATERIALE MATERIAL	TRATTAMENTO TREATMENT
1	Corpo - Body	Acciaio inox AISI 316 Stainless steel AISI 316	
2	Guarnizione - Gasket	PTFE	
3	Guarnizione - Gasket	FKM	
4	Molla - Spring	Acciaio inox AISI 316 Stainless steel AISI 316	
5	Otturatore - Disc	Acciaio inox AISI 316 Stainless steel AISI 316	
6	Corpo - Body	Acciaio inox AISI 316 Stainless steel AISI 316	

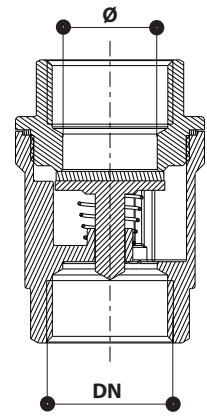
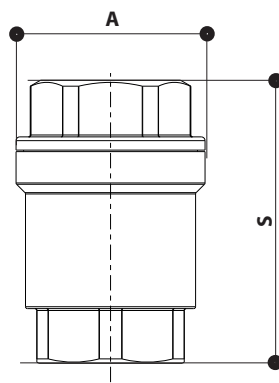

DN	Ø	S	A	Kv m ³ /h
1/4"	8	53	30.5	2.1
3/8"	10	53	30.5	2.8
1/2"	15	56	37.5	4.4
3/4"	20	63	42	6.8
1"	25	74	48	10
1 1/4"	30	81	58	17
1 1/2"	38	91	70	26
2"	47	97	82	43
2 1/2"	61	118	102.5	75
3"	75	138	120	112
4"	94	158	150	172

DIMENSIONI - DIMENSIONS (mm)

Tutte le caratteristiche tecniche dei prodotti sono soggette a modifiche senza preavviso - All product's technical specifications are subject to modification without prior notice